

SSB-20

LED LIGHT STRIPS FROM PLASHLIGHTS.COM:
COOL WHITE OR R/G/B LIGHT STRIPS DESIGNED AND MANUFACTURED EXCLUSIVELY FOR FAST-FLAG. THIS FEATURE MAY BE INCLUDED WHEN SPECIFIED WITH YOUR ORDER. CONTACT FAST-FLAG FOR MORE INFORMATION.

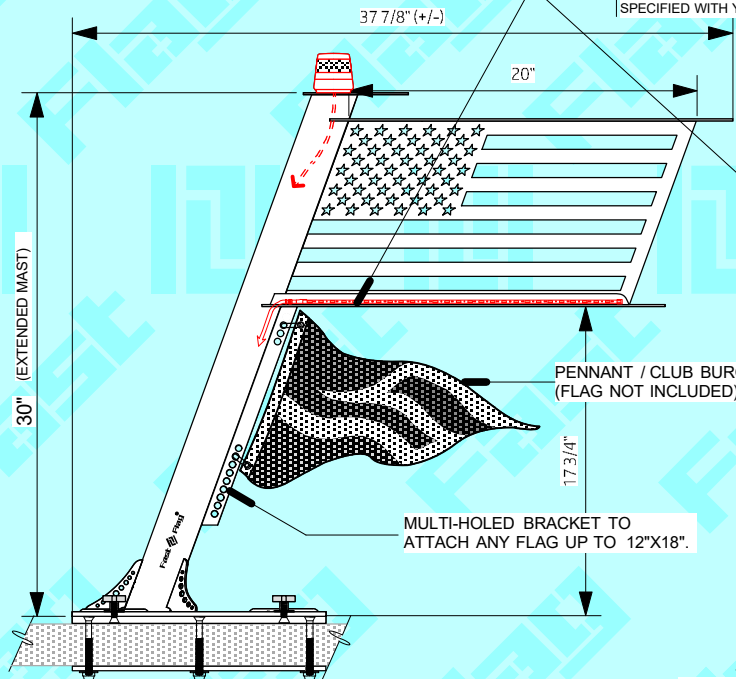

SSB-20FDB STENCIL

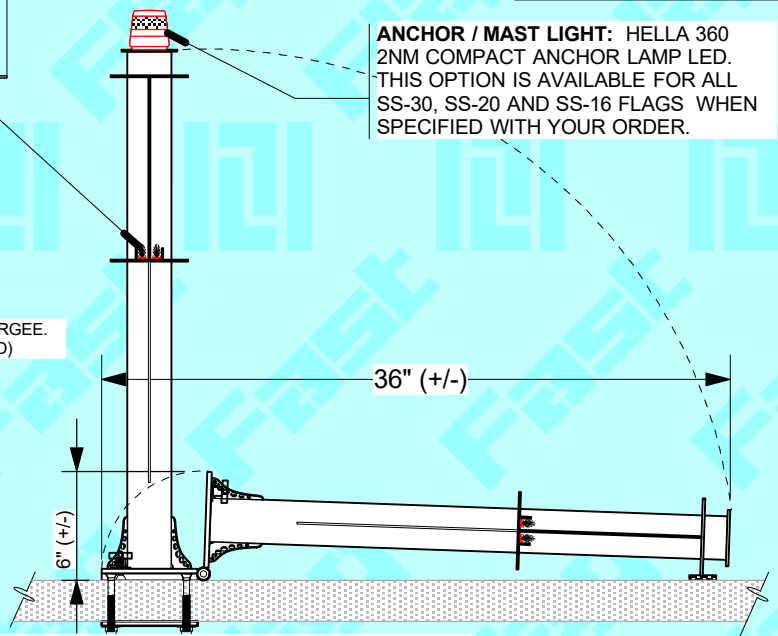

SSB-20FDB SOLID/STENCIL (AFT VIEW)

ANCHOR / MAST LIGHT: HELLA 360 2NM COMPACT ANCHOR LAMP LED. THIS OPTION IS AVAILABLE FOR ALL SS-30, SS-20 AND SS-16 FLAGS WHEN SPECIFIED WITH YOUR ORDER.

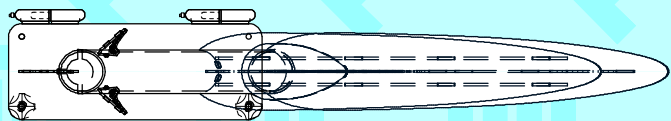

SSB-20FDB STENCIL (TOP VIEW)

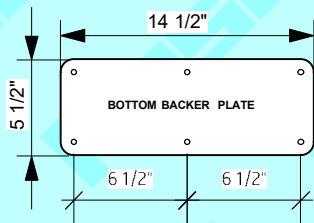

BOTTOM BACKER PLATE TO BE THROUGH BOLTED TO FLAG'S LOWER PLATE AS NEEDED PER EXISTING CONDITIONS.

AS EACH INSTALLATION IS UNIQUE AND DIFFERENT, INSTALLATION HARDWARE IS NOT INCLUDED. VERIFY ALL PERTINENT DIMENSIONS/MEASUREMENTS SPECIFIC TO YOUR BOATS HARDTOP/DECK THICKNESS AND SIZE ACCORDINGLY. NOTE: DEPENDING ON THE CONSTRUCTION OF YOUR BOAT/VESSELS TOP/DECK, SOME MODIFICATIONS AND/OR ADJUSTMENTS MAY BE NECESSARY TO COMPLETE YOUR INSTALLATION.

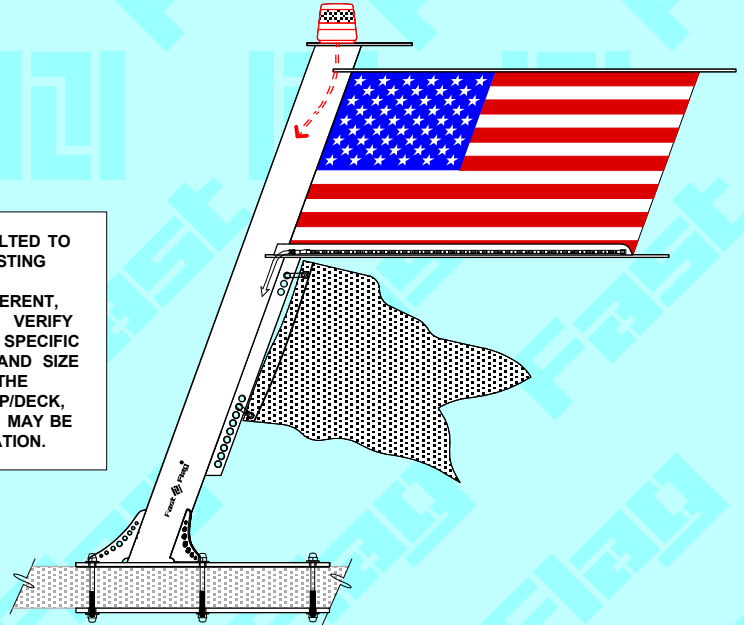

SSB-20 FIXED BASE SOLID

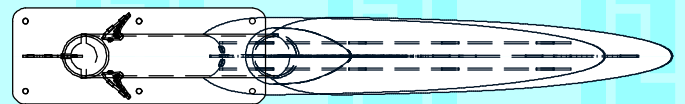

SSB-20 FIXED BASE (TOP VIEW)

SSB-20 FDB/FIXED BASE

SOLID / STENCIL

THE SSB-20 IS AN AMERICAN FLAG WITH AN INTEGRAL MULTI-HOLED BRACKET TO RECEIVE YOUR YACHT CLUB BURGEE OR PENNANT. THE AMERICAN FLAG IS AVAILABLE IN SOLID RED/WHITE & BLUE STARS AND STRIPES AS WELL AS OUR CONTEMPORARY STENCIL DESIGN WITH THE STARS AND STRIPES BEING LASER CUT TO ALLOW LIGHT TO PASS THROUGH. OTHER AVAILABLE FEATURES AND OPTIONS FOR THIS FLAG INCLUDE: MAST LIGHT/ANCHOR LIGHT, AS WELL AS LED LIGHT STRIPS FROM PLASHLIGHTS.COM. CONTACT FAST-FLAG FOR FURTHER INFORMATION.

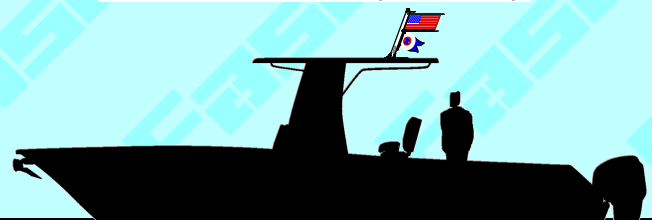

SSB-20-FDB SOLID & STENCIL AMERICAN FLAG

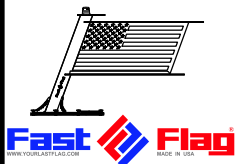

U.S. Patent No. 10,783,812
U.S. Patent No. 10,783,813
U.S. Patent No. D969,669 S
U.S. Patent No. D1,055,760 S
U.S. Patent No. D1,055,761 S
Other Patents Pending.

FAST-FLAG LLC
NAPLES, FL USA

Made in USA
www.yourlastflag.com